

132x64 Cholesteric Display Development Kit

Development Kit



Display with Chip-on-Flex Controller



Development Module



Product Description

The 132x64 Development Kit contains everything required to quickly evaluate the features and capabilities of the **132x64 Cholesteric LCD Module**.

Each development kit contains a display module with embedded controller, development module, AAA cell holder assembly, batteries, A/C power supply, PC to development module serial communication cable, JTAG programming device, software CD with source code samples, TI Code Composer Essentials development environment, user interface software, and related documentation.

The 132x64 Display Module is intended for general purpose graphic and character display applications. All Kent Displays Cholesteric Liquid Crystal Display (ChLCD) products take advantage of the technology's unique "No Power" attribute without compromising superior optical performance even in direct sunlight. Display modules include an embedded controller to generate the required driving waveforms using temperature data provided by the host system.

The Development Module is designed to enable OEMs to quickly integrate the **132x64 Display Module with Chip-on-Flex Controller** into their products. The Development Module is a reference design, providing an example of how to interface with the Display Module. The preloaded firmware enables the user to load up to 12 bitmap images via the PC slide show software. Sample code is included for demonstrating all of the display's features and commands. A 16KB-limit version of TI's Code Composer Essentials development environment and a JTAG programming device are also included to aid in custom code development.

Kent Displays, Inc.
343 Portage Boulevard
Kent, OH 44240, USA

Telephone: 330.673.8784
Fax: 330.673.4408
Sales: sales@kentdisplays.com
Website: www.kentdisplays.com

Product Features

Display Module:

- 132 Columns x 64 Rows
- Superior Brightness
- Approximate size: 3.1x1.9x0.06 Inches
- Excellent Optical Properties
- Available in Multiple Color Schemes
- Viewing Cone Comparable to Paper
- Low Profile, Compact Design
- Indefinite Image Memory (“No Power”)

Controller:

- Serial Command and Data Interface
- Integrated DC/DC Charge Pump

*The 132x64x3.0 Display Module included in the Development Kit is part number: 01568301208. Refer to the 132x64x3.0 datasheet (25112) for additional information.

Typical 132x64 Display Applications

- Battery Powered Portable Devices
- Instrumentation Displays
- Machine Interface
- Remote Control Display Applications
- Inventory Tracking Displays
- USB Powered Devices

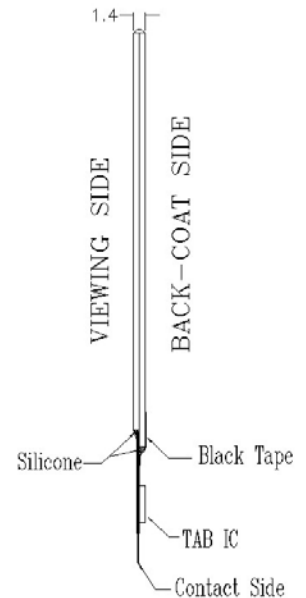
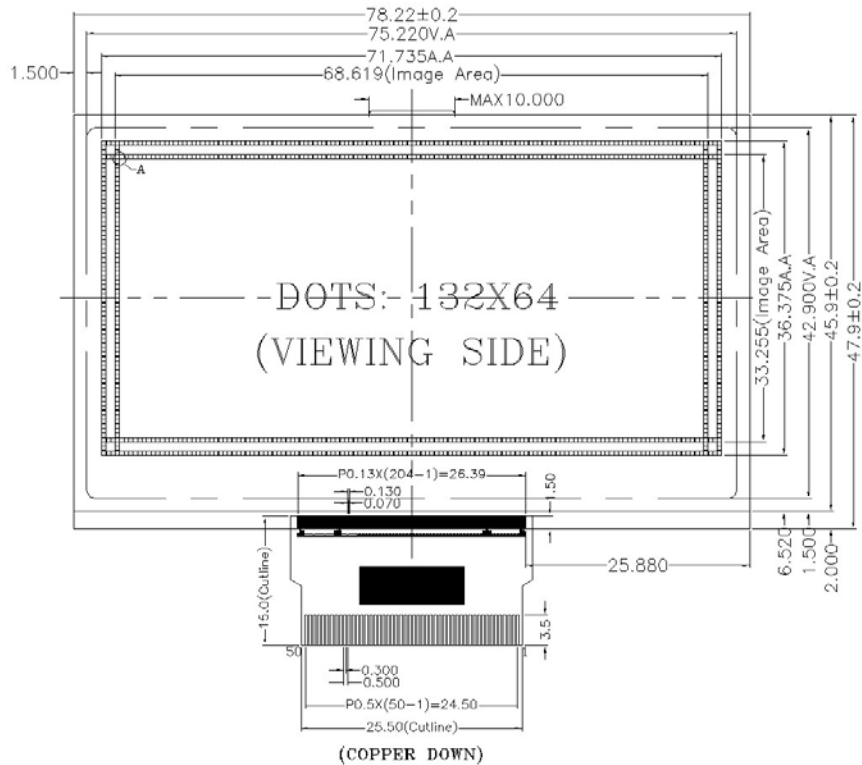

DETAIL: A
SCALE: 4:1

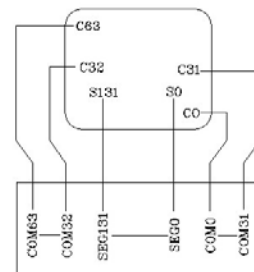

Ordering Information:

Development Kit	
Part #	Description
09003801208	Development Kit, 132x64 White/Blue

Contact Kent Displays at sales@kentdisplays.com for complete display assemblies, custom configurations, pricing, and additional information.

Development Kit Display Module and Controller:

General Specifications	
Parameter	Description
Display Type	Cholesteric Reflective LCD
Format	132 Columns x 64 Rows
Resolution	49 dots per inch (0.52mm pixel pitch, horizontal & vertical)
Image Area	2.70 in x 1.31 in (68.6mm x 33.3 mm)
Display Module Weight	0.466 oz (13.2 grams)
Operating Temperature Range	0°C to +50°C
Storage Temperature Range	-30°C to +80°C
Full Image Update Rate	1.4 sec. @ 25°C

Absolute Maximum Ratings			
Parameter	Symbol	Rating	Units
IC Logic Supply	V_{DD}	-0.3 to +3.6	V
Interface Logic Supply	V_{DDIO}	-0.3 to $\min(V_{DD}+0.5, +3.6)$	V
DC/DC Supply	V_{CI}	-0.3 to +3.6	V
Input Voltage	V_{in}	-0.3 to $(V_{DDIO} + 0.3)$	V
Operating Temperature	T_{OPR}	0 to +50	°C
Storage Temperature	T_{STR}	-30 to +80	°C

Conditions: $T_A = 25\text{ °C}$

Parameter	Symbol	Min.	Typ.	Max.	Units	
IC Logic Supply	V_{DD}	+2.4	+2.8	+3.5	V	
Interface Logic Supply	V_{DDIO}	+1.6	-	V_{DD}	V	
DC/DC Supply	V_{CI}	V_{DD}	-	+3.5	V	
Input Voltage	High	V_{IH}	0.8 V_{DDIO}	-	V_{DDIO}	V
	Low	V_{IL}	V_{SS}	-	0.2 V_{DDIO}	V
Output Voltage	High	V_{OH}	0.9 V_{DDIO}	-	V_{DDIO}	V
	Low	V_{OL}	V_{SS}	-	0.1 V_{DDIO}	V
Sleep Mode Current ¹	I_{SLP}	-	+1	+15	µA	

¹ I_{SLP} is the sum of V_{DD} , V_{DDIO} , and V_{CI} currents measured with $V_{DD} = V_{DDIO} = V_{CI} = 2.8V$.

* Specifications are subject to change without prior notice.

Development Kit Controller Module:

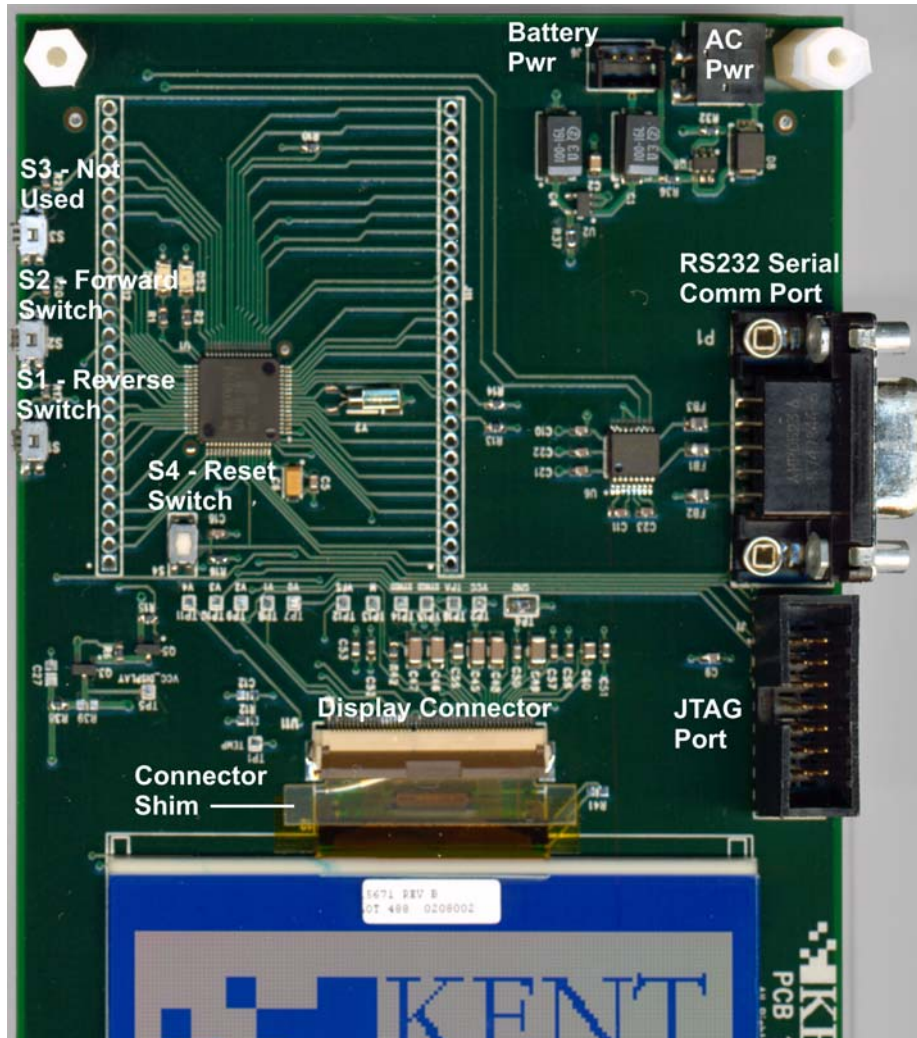

Stand-Alone Demo Use:

The 132x64 Development Kit can be used as a stand-alone demo by using two of the three switches at the left edge of the Development Kit Controller Module. Refer to the figure above for the switch locations. Pressing S1 displays the image preceding the current image. Pressing S2 advances to the next image in flash memory. S3 is not used.

The JTAG port and cables are used to program the Development Kit Controller for other applications. Refer to the TI Code Composer Essentials application on the Development Kit software CD, or visit <http://focus.ti.com/docs/toolsw/folders/print/msp-cce430.html> for additional information.

There is a reset switch (S4) located near S1. This switch resets the Development Kit Controller microprocessor and the Display controller.

Development Kit Software Tools:

The Development Kit includes software tools that allow the user to load their own slideshows into flash memory, convert bitmap files to C-code, and convert BDF fonts into C-code. Sample code is also provided for all of the display command set. The figure below shows the application window for the PC-based slideshow tool.

132x64 SlideShow Application Window:



Display Controller Block Diagram:

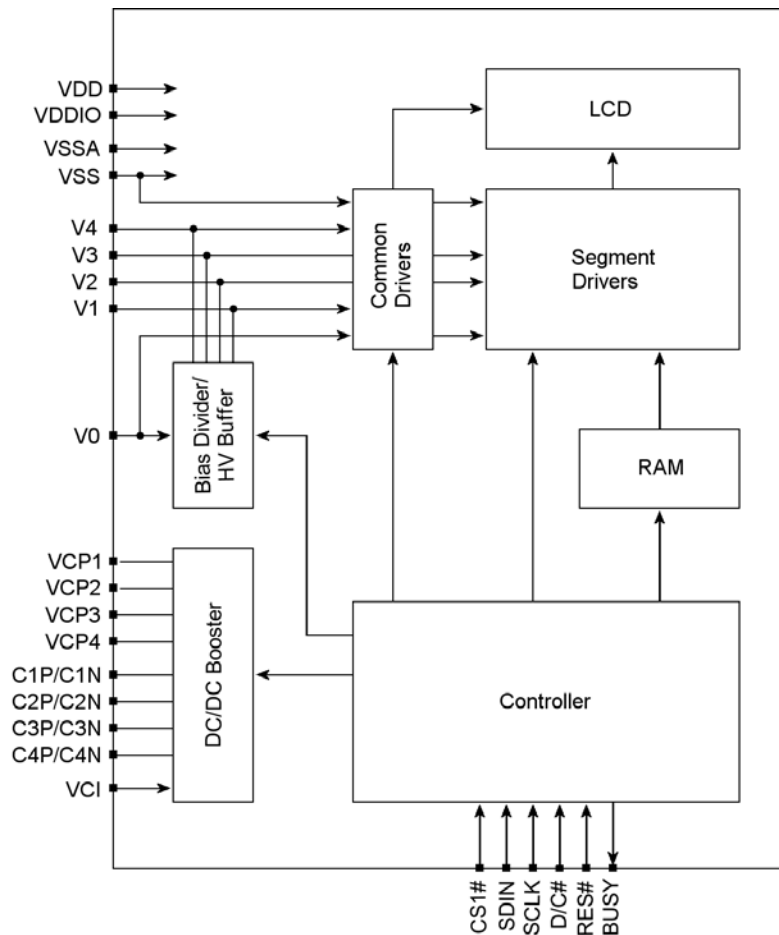

Optical Characteristics for Standard Color Configurations

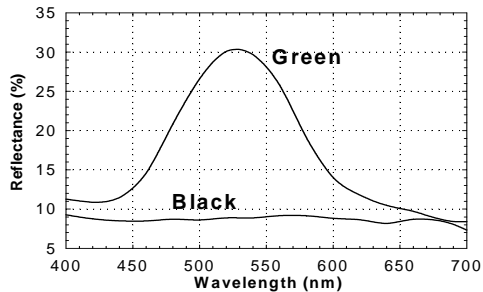
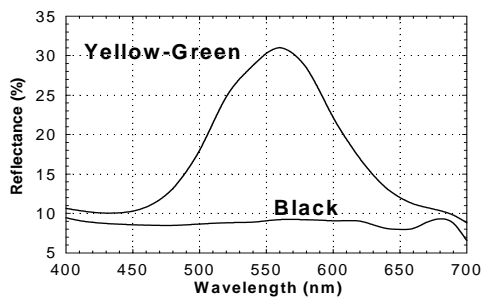
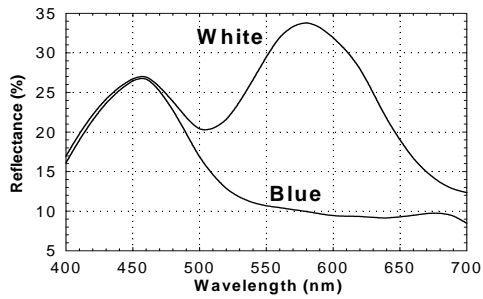
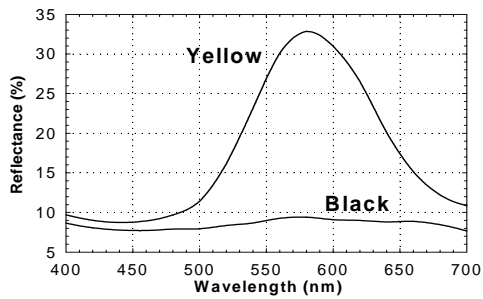

The above reflectance curves are from a single pixel. Actual reflectance will vary depending on display resolution, aperture ratio, and other factors.

The graphs to the left outline the spectral reflectance characteristics for a given display pixel when switched to either of the two possible stable states: reflective planar or transparent focal conic. The top line in each chart outlines the reflective characteristic of the planar state. The bottom line outlines the reflective characteristic of the transparent focal conic state. Graphs for the 4 standard color combinations are illustrated.

Contrast Ratio Polar Representation

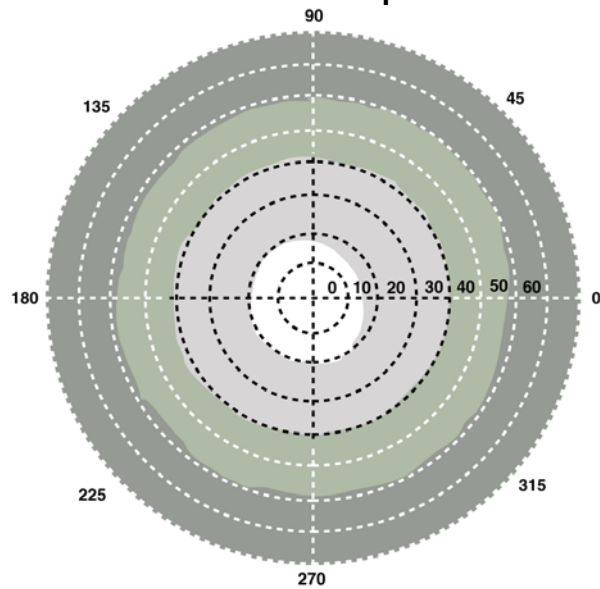

As illustrated in the polar graph above, all Kent Displays' ChLCD products have a 360-degree viewing cone. When measured normal to the plane of the display, the monochromatic contrast ratio is as high as 25:1 with a peak reflectivity approaching 35% of the incident light. The contrast ratio reduces as the viewing angle approaches the plane of the display but is still excellent at 11:1. Since no polarizers are used, display contrast reduces uniformly in all azimuthal directions when the viewing angle is increased.

Products and technologies of Kent Displays, Inc. are protected by the US Patents: 5,493,430, 5,570,216, 5,636,044, 5,644,330, 5,251,048, 5,384,067, 5,437,811, 5,453,863, 5,668,614, 5,691,796, 5,695,682, 5,748,277, 5,766,694, 5,847,798 and numerous other patent applications by Kent Display Systems, Inc., Kent Displays, Inc. and Kent State University pending in the U.S. and in foreign patent filings include: PCT, Canada, China, Europe, Israel, Japan, Korea, and Taiwan among others.